

Features

- N channel
- Enhancement mode
- Temperature sensor with thyristor characteristic
- The drain pin is electrically shorted to the tab

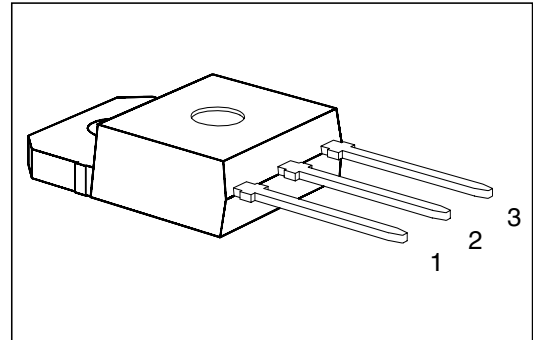

Pin	1	2	3
	G	D	S

Type	V_{DS}	I_D	$R_{DS(on)}$	Package	Ordering Code
BTS 240A	50 V	58 A	0.018 Ω	TO-218AA	C67078-A5100-A3

Maximum Ratings

Parameter	Symbol	Values	Unit
Drain-source voltage	V_{DS}	50	V
Drain-gate voltage, $R_{GS} = 20 \text{ k}\Omega$	V_{DGR}	50	
Gate-source voltage	V_{GS}	± 20	
Continuous drain current, $T_C = 73 \text{ }^\circ\text{C}$	I_D	58	A
ISO drain current $T_C = 85 \text{ }^\circ\text{C}$, $V_{GS} = 10 \text{ V}$, $V_{DS} = 0.5 \text{ V}$	I_{D-ISO}	21.0	
Pulsed drain current, $T_C = 25 \text{ }^\circ\text{C}$	$I_{D \text{ puls}}$	232	
Short circuit current, $T_j = -55 \dots +150 \text{ }^\circ\text{C}$	I_{SC}	147	
Short circuit dissipation, $T_j = -55 \dots +150 \text{ }^\circ\text{C}$	P_{SCmax}	2200	W
Power dissipation	P_{tot}	170	
Operating and storage temperature range	T_j , T_{stg}	$-55 \dots +150$	$^\circ\text{C}$
DIN humidity category, DIN 40 040	–	E	–
IEC climatic category, DIN IEC 68-1	–	55/150/56	
Thermal resistance			K/W
Chip-case	$R_{th \text{ JC}}$	≤ 0.74	
Chip-ambient	$R_{th \text{ JA}}$	≤ 45	

Electrical Characteristics

 at $T_j = 25\text{ °C}$, unless otherwise specified.

Parameter	Symbol	Values			Unit
		min.	typ.	max.	

Static Characteristics

Drain-source breakdown voltage $V_{GS} = 0, I_D = 0.25\text{ mA}$	$V_{(BR)DSS}$	50	–	–	V
Gate threshold voltage $V_{GS} = V_{DS}, I_D = 1\text{ mA}$	$V_{GS(th)}$	2.5	3.0	3.5	
Zero gate voltage drain current $V_{GS} = 0\text{ V}, V_{DS} = 50\text{ V}$ $T_j = 25\text{ °C}$ $T_j = 125\text{ °C}$	I_{DSS}	– –	0.1 10	1.0 100	μA
Gate-source leakage current $V_{GS} = 20\text{ V}, V_{DS} = 0$ $T_j = 25\text{ °C}$ $T_j = 150\text{ °C}$	I_{GSS}	– –	10 2.0	100 4.0	nA μA
Drain-source on-state resistance $V_{GS} = 10\text{ V}, I_D = 47\text{ A}$	$R_{DS(on)}$	–	0.012	0.018	Ω

Dynamic Characteristics

Forward transconductance $V_{DS} \geq 2 \times I_D \times R_{DS(on)max}, I_D = 47\text{ A}$	g_{fs}	20.0	43.0	–	S
Input capacitance $V_{GS} = 0, V_{DS} = 25\text{ V}, f = 1\text{ MHz}$	C_{iss}	–	2.9	4.3	nF
Output capacitance $V_{GS} = 0, V_{DS} = 25\text{ V}, f = 1\text{ MHz}$	C_{oss}	–	1.4	2.1	
Reverse transfer capacitance $V_{GS} = 0, V_{DS} = 25\text{ V}, f = 1\text{ MHz}$	C_{rss}	–	0.5	0.8	
Turn-on time t_{on} , ($t_{on} = t_{d(on)} + t_r$) $V_{CC} = 30\text{ V}, V_{GS} = 10\text{ V}, I_D = 3\text{ A}, R_{GS} = 50\text{ }\Omega$	$t_{d(on)}$	–	50	75	ns
	t_r	–	150	230	
Turn-off time t_{off} , ($t_{off} = t_{d(off)} + t_f$) $V_{CC} = 30\text{ V}, V_{GS} = 10\text{ V}, I_D = 3\text{ A}, R_{GS} = 50\text{ }\Omega$	$t_{d(off)}$	–	350	560	
	t_f	–	250	330	

Electrical Characteristics (cont'd)

 at $T_j = 25\text{ °C}$, unless otherwise specified.

Parameter	Symbol	Values			Unit
		min.	typ.	max.	

Reverse Diode

Continuous source current	I_S	–	–	58	A
Pulsed source current	I_{SM}	–	–	232	
Diode forward on-voltage $I_F = 58\text{ A}$, $V_{GS} = 0\text{ V}$	V_{SD}	–	1.4	1.8	V
Reverse recovery time $I_F = I_S$, $di_F/dt = 100\text{ A}/\mu\text{s}$, $V_R = 30\text{ V}$	t_{rr}	–	100	–	ns
Reverse recovery charge $I_F = I_S$, $di_F/dt = 100\text{ A}/\mu\text{s}$, $V_R = 30\text{ V}$	Q_{rr}	–	0.3	–	μC

Temperature Sensor

Forward voltage $I_{TS(on)} = 10\text{ mA}$, $T_j = -55 \dots +150\text{ °C}$ Sensor override, $t_p \leq 100\text{ }\mu\text{s}$ $T_j = -55 \dots +160\text{ °C}$	$V_{TS(on)}$	0.7	1.4	1.5	V
		–	–	10	
Forward current $T_j = -55 \dots +150\text{ °C}$ Sensor override, $t_p \leq 100\text{ }\mu\text{s}$ $T_j = -55 \dots +160\text{ °C}$	$I_{TS(on)}$	–	–	10	mA
		–	–	600	
Holding current, $V_{TS(off)} = 5\text{ V}$, $T_j = 25\text{ °C}$ $T_j = 150\text{ °C}$	I_H	0.05 0.05	0.1 0.2	0.5 0.3	
Switching temperature $V_{TS} = 5\text{ V}$	$T_{TS(on)}$	150	–	–	°C
Turn-off time $V_{TS} = 5\text{ V}$, $I_{TS(on)} = 2\text{ mA}$	t_{off}	0.5	–	2.5	μs

Examples for short-circuit protection

 at $T_j = -55 \dots +150 \text{ }^\circ\text{C}$, unless otherwise specified.

Parameter	Symbol	Examples			Unit
		1	2	–	
Drain-source voltage	V_{DS}	15	30	–	V
Gate-source voltage	V_{GS}	6.4	5.1	–	
Short-circuit current	I_{SC}	< 147	< 67	–	A
Short-circuit dissipation	P_{SC}	< 2200	< 2000	–	W
Response time $T_j = 25 \text{ }^\circ\text{C}$, before short circuit	$t_{SC(off)}$	< 25	< 25	–	ms

Short-circuit protection $I_{SC} = f(V_{DS})$

 Parameter: V_{GS}

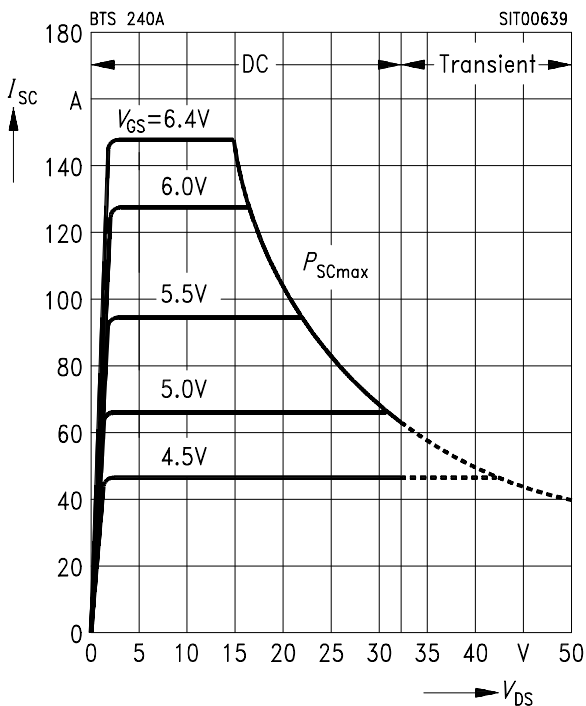
 Diagram to determine I_{SC} for $T_j = -55 \dots +150 \text{ }^\circ\text{C}$

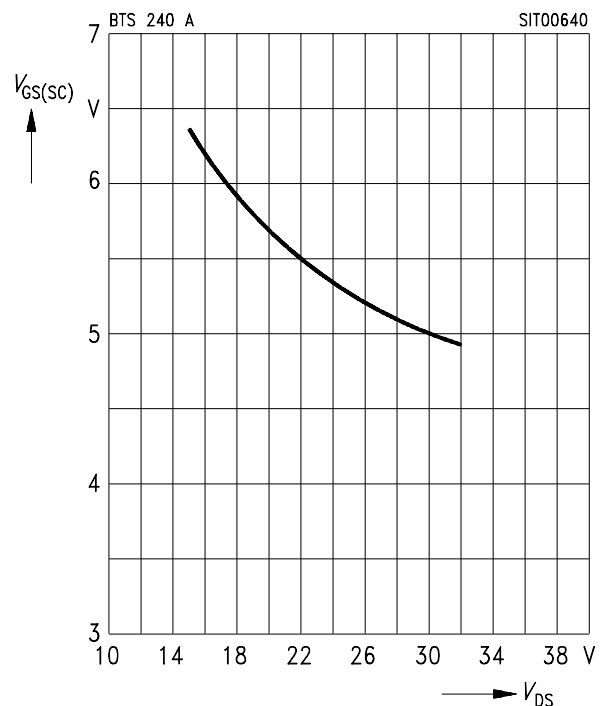
Max. gate voltage $V_{GS(SC)} = f(V_{DS})$

 Parameter: $T_j = -55 \dots +150 \text{ }^\circ\text{C}$

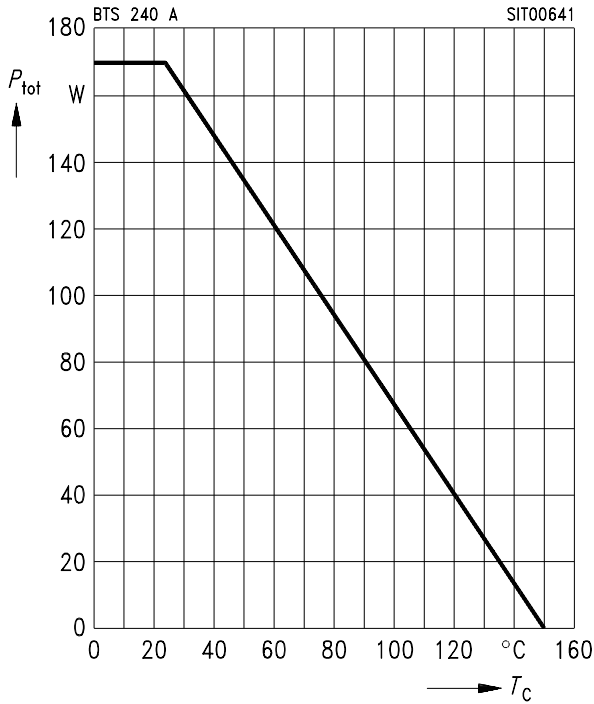
Max. power dissipation $P_{tot} = f(T_C)$



Typ. drain-source on-state resistance $R_{DS(on)} = f(I_D)$

Parameter: V_{GS}

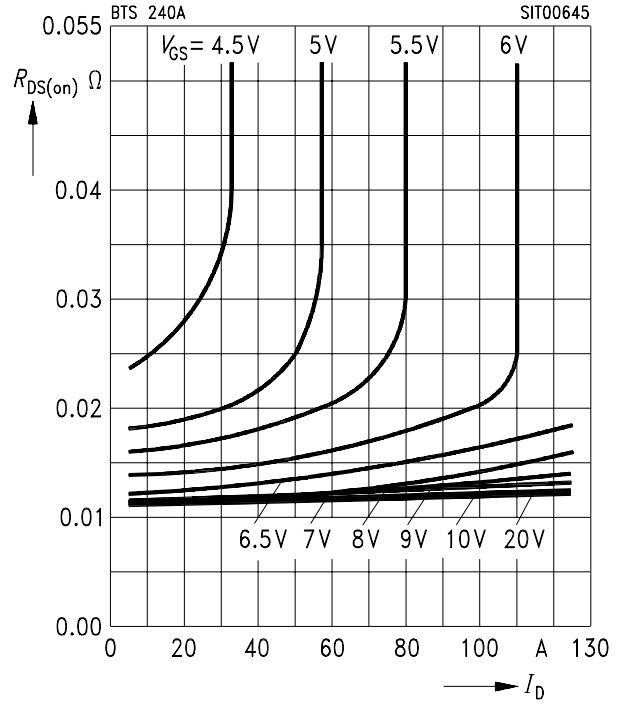

Typical output characteristics $I_D = f(V_{DS})$

Parameter: $t_p = 80 \mu s$

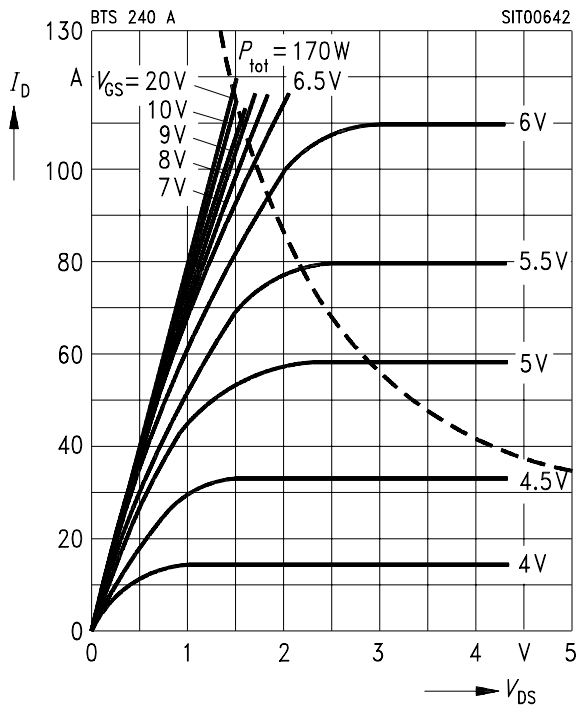

Safe operating area $I_D = f(V_{DS})$

Parameter: $D = 0.01, T_C = 25^\circ C$

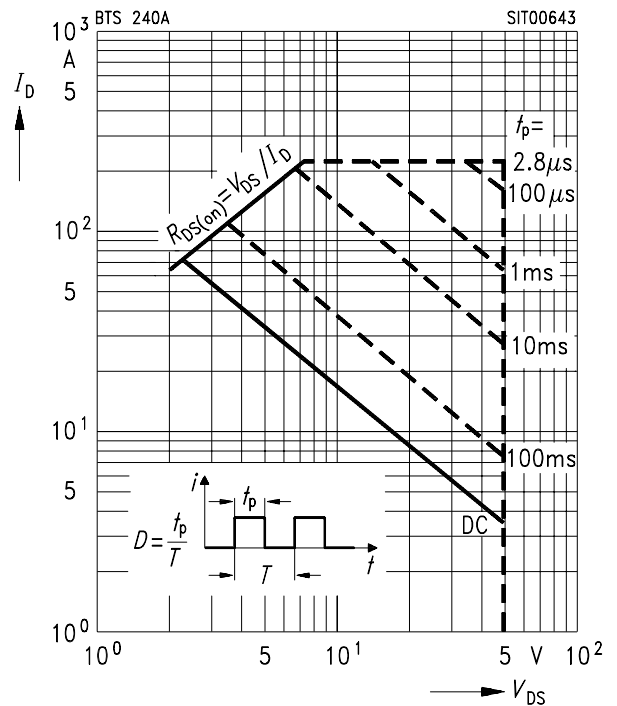

Drain-source on-state resistance

$R_{DS(on)} = f(T_j)$

Parameter: $I_D = 47\text{ A}$, $V_{GS} = 10\text{ V}$ (spread)

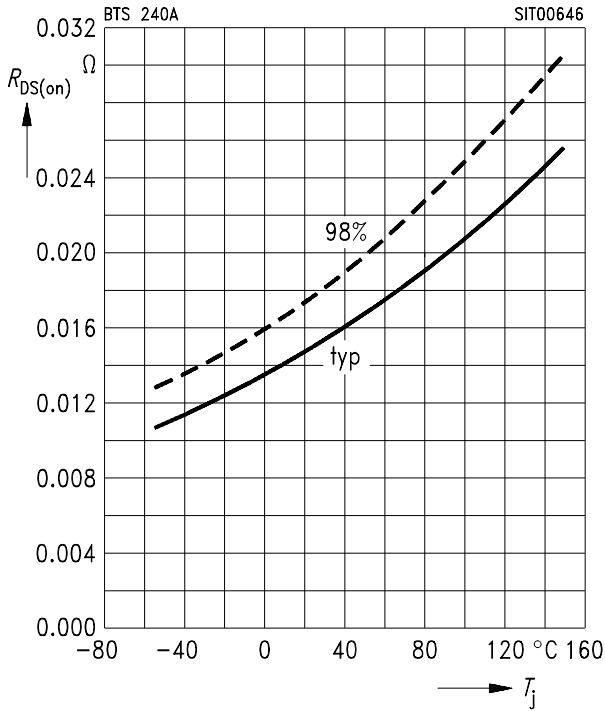

Gate threshold voltage $V_{GS(th)} = f(T_j)$

Parameter: $V_{DS} = V_{GS}$, $I_D = 1\text{ mA}$

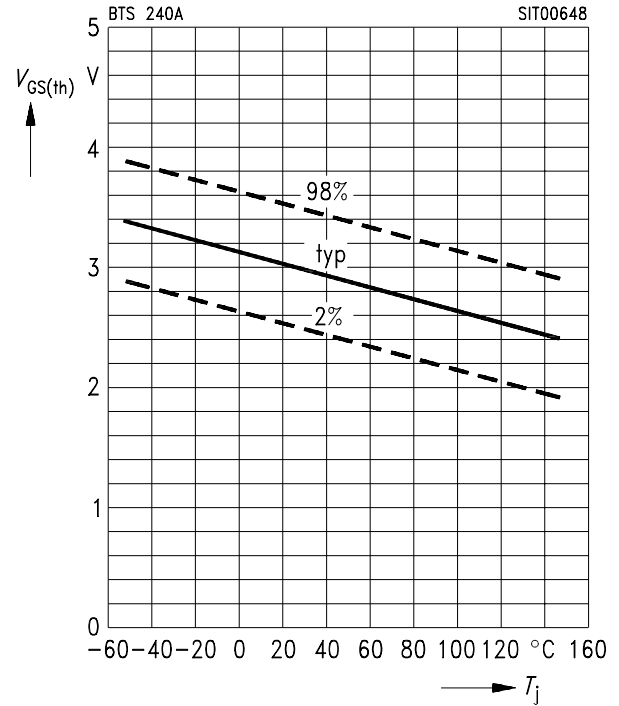

Typ. transfer characteristic

$I_D = f(V_{GS})$

Parameter: $t_p = 80\text{ }\mu\text{s}$, $V_{DS} = 25\text{ V}$

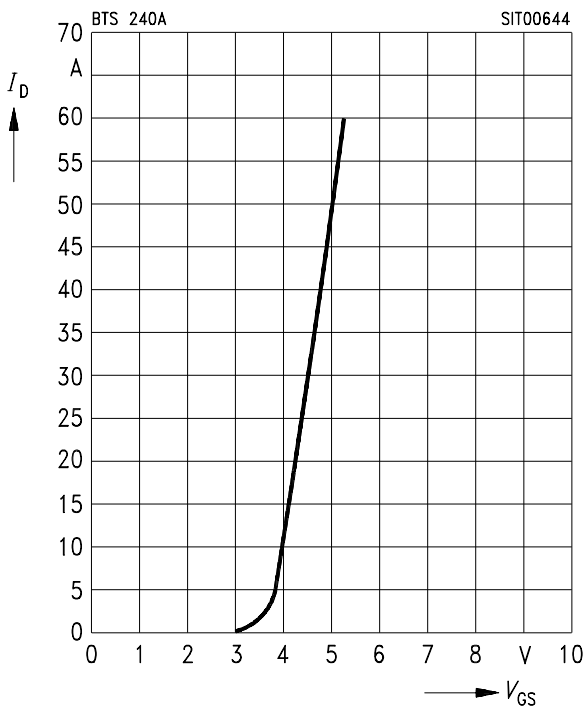

Typ. transconductance $g_{fs} = f(I_D)$

Parameter: $t_p = 80\text{ }\mu\text{s}$, $V_{DS} = 25\text{ V}$

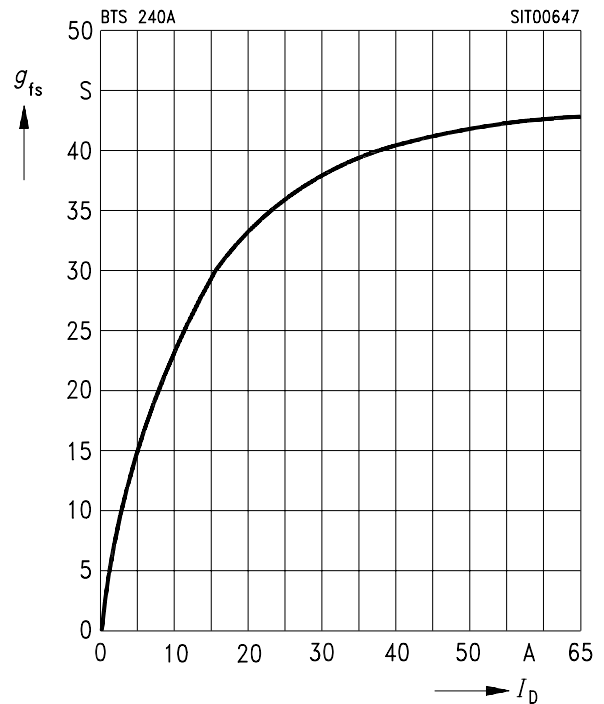

Continuous drain current $I_D = f(T_C)$

Parameter: $V_{GS} \geq 10\text{ V}$

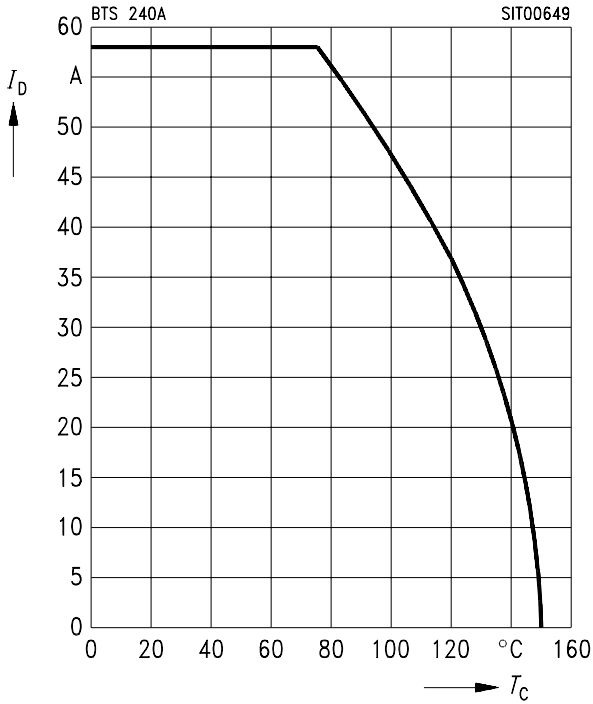

Forward characteristics of reverse diode $I_F = f(V_{SD})$

Parameter: $T_j, t_p = 80\ \mu\text{s}$ (spread)

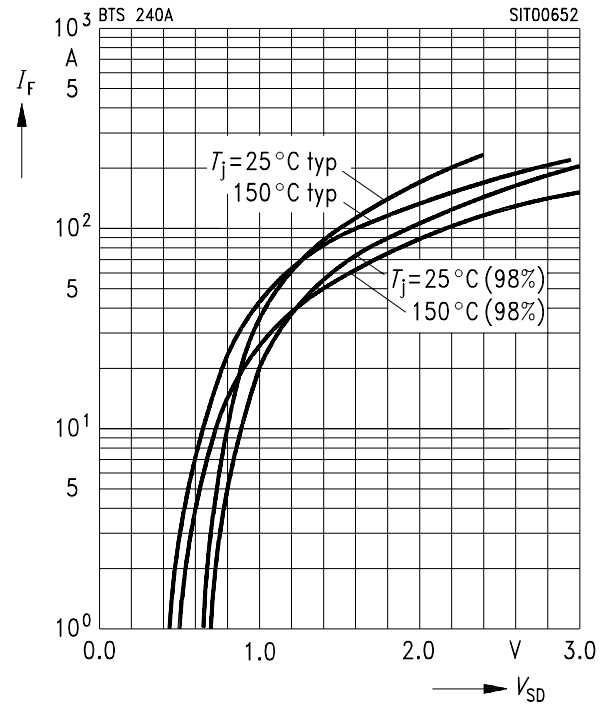

Typ. gate-source leakage current $I_{GSS} = f(T_C)$

Parameter: $V_{GS} = 20\text{ V}, V_{DS} = 0$

Parameter: $V_{GS} = 20\text{ V}, V_{DS} = 0$

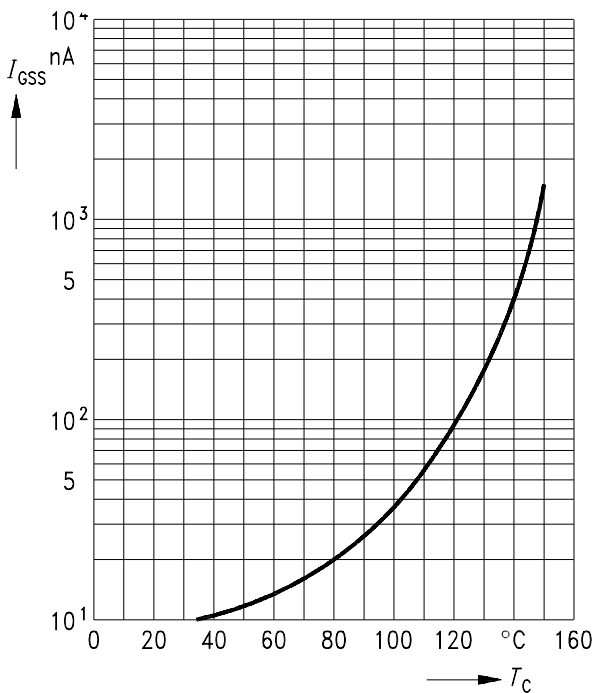

Typ. capacitances $C = f(V_{DS})$

Parameter: $V_{GS} = 0, f = 1\text{ MHz}$

Parameter: $V_{GS} = 0, f = 1\text{ MHz}$

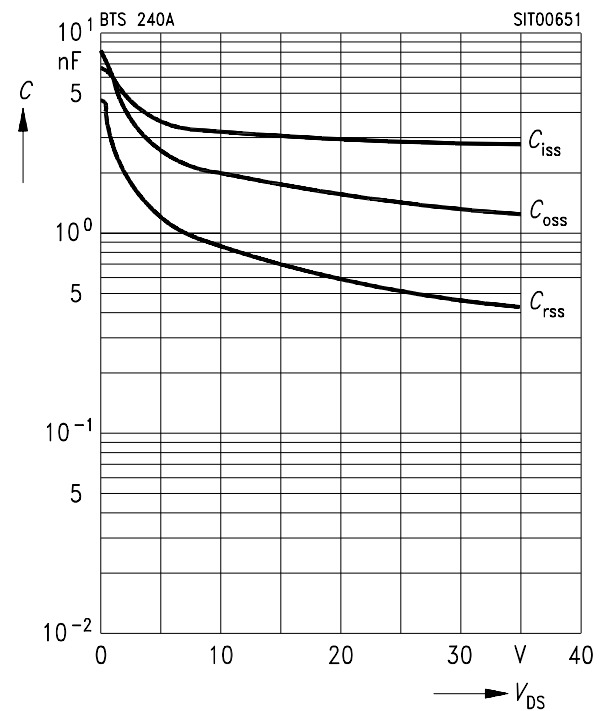

Transient thermal impedance $Z_{thJC} = f(t_p)$
 Parameter: $D = t_p/T$

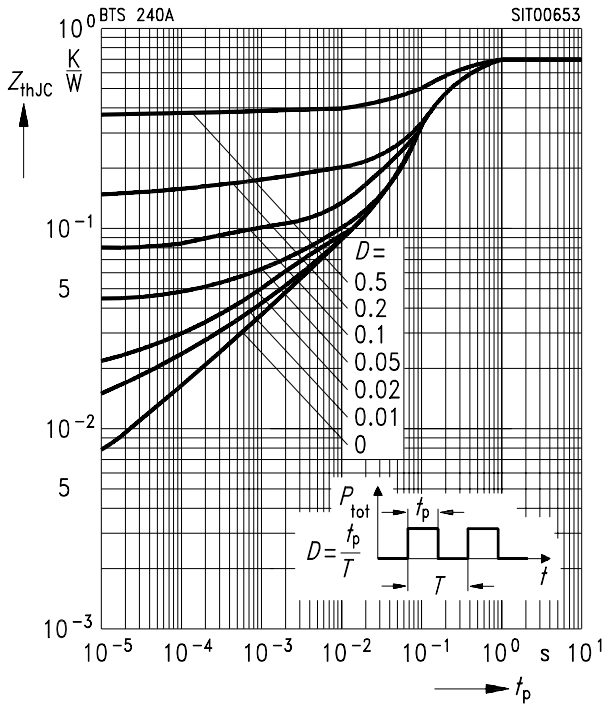

TO-218 AA
Standard

Ordering Code
C67078-S5100-A3

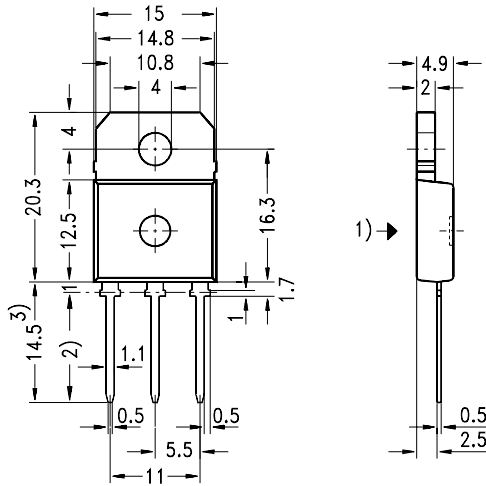

- 1) punch direction, burr max. 0.04
- 2) dip tinning
- 3) max. 15.5 by dip tinning press burr max. 0.05

Edition 04.97

**Published by Infineon Technologies AG,
St.-Martin-Strasse 53,
D-81541 München, Germany**

**© Infineon Technologies AG 2000.
All Rights Reserved.**

Attention please!

The information herein is given to describe certain components and shall not be considered as warranted characteristics.

Terms of delivery and rights to technical change reserved.

We hereby disclaim any and all warranties, including but not limited to warranties of non-infringement, regarding circuits, descriptions and charts stated herein.

Infineon Technologies is an approved CECC manufacturer.

Information

For further information on technology, delivery terms and conditions and prices please contact your nearest Infineon Technologies Office in Germany or our Infineon Technologies Representatives worldwide (see address list).

Warnings

Due to technical requirements components may contain dangerous substances. For information on the types in question please contact your nearest Infineon Technologies Office.

Infineon Technologies Components may only be used in life-support devices or systems with the express written approval of Infineon Technologies, if a failure of such components can reasonably be expected to cause the failure of that life-support device or system, or to affect the safety or effectiveness of that device or system. Life support devices or systems are intended to be implanted in the human body, or to support and/or maintain and sustain and/or protect human life. If they fail, it is reasonable to assume that the health of the user or other persons may be endangered.